

Hardware details

Breakout board

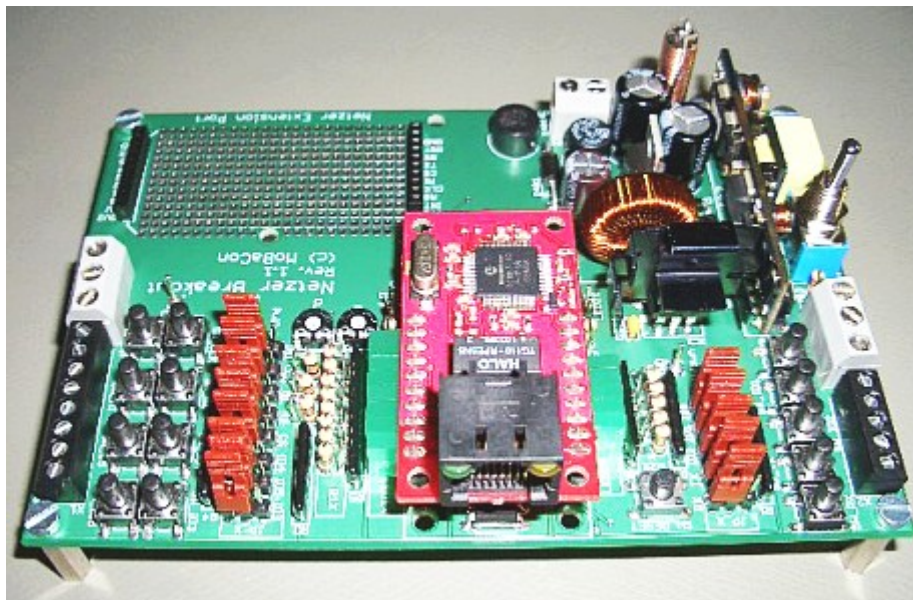

The Netzer Breakout enables quick development of circuits around the Networker.

- Schematics: [Open](#)
- Description and assembly manual: [Open](#)

The image shows a functional block diagram of the board.

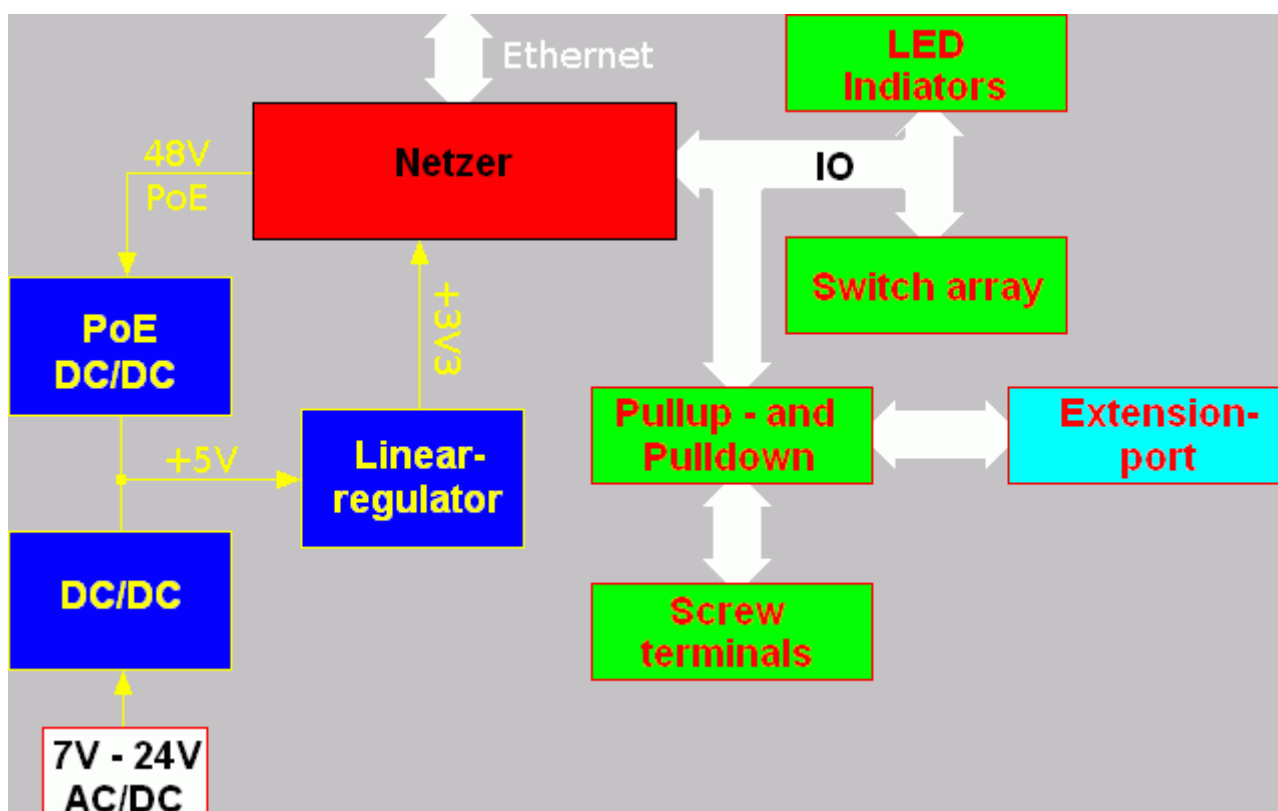

The extension port has an important role. Depending on the application several extension boards can be put in the socket. Extension boards for **LCD** and **domestic** (relays, temperatur and light sensors, opto decoupled inputs) are in development.

Eagle Libraries

For new Eagle projects here is Netzer in an easy to use library (Release from 2011-07-01): [Open](#) (Eagle version 5.X)

Also included are footprints and device for the extension port to develop own extension boards for the breakout.

Schematics

- Eagle file: [Open](#)
- PDF: [Open](#)

Layout

- Eagle file: [Open](#)
- PDF (Top layer): [Open](#)
- PDF (Bottom layer, mirrored): [Open](#)
- PDF (Parts, top layer): [Open](#)

From:

<http://mobacon.de/dokuwiki/> - **MoBaCon**

Permanent link:

<http://mobacon.de/dokuwiki/doku.php?id=en:netzer:hardware&rev=1322401761>

Last update: **2025/06/11 20:42**

